

Type FSMD0805

SMD Polyswith Resettable Devices



Performance Specification

Model	Marking	V max (Vdc)	I max (A)	I hold @25°C (A)	I trip @25°C (A)	P _d Typ. (W)	Maximum		Resistance	
							Time To Trip		R i min (Ω)	R1max (Ω)
							Current (A)	Time (Sec)		
SMD0805R005SF	1	15.0	30	0.05	0.15	0.5	0.5	1.50	1.500	18.000
SMD0805R005SF30v	1	30.0	30	0.05	0.15	0.5	0.5	1.50	1.500	18.000
SMD0805R010SF	1	15.0	100	0.10	0.30	0.5	0.5	1.50	0.750	6.000
SMD0805R010SF30v	1	30.0	30	0.10	0.30	0.5	0.5	1.50	0.750	6.000
SMD0805R020SF	2	9.0	30	0.20	0.50	0.5	8.0	0.02	0.550	3.500
SMD0805R020SF12v	2	12.0	30	0.20	0.50	0.5	8.0	0.02	0.550	3.500
SMD0805R020SF16v	2	16.0	30	0.20	0.50	0.5	8.0	0.02	0.550	3.500
SMD0805R020SF24v	2	24.0	30	0.20	0.50	0.5	8.0	0.02	0.550	3.500
SMD0805R035SF	3	6.0	100	0.35	0.75	0.5	8.0	0.10	0.200	1.200
SMD0805R035SF12v	3	12.0	30	0.35	0.75	0.5	8.0	0.10	0.200	1.200
SMD0805R035SF13.2v	3	13.2	30	0.35	0.75	0.5	8.0	0.10	0.200	1.200
SMD0805R035SF16v	3	16.0	30	0.35	0.75	0.5	8.0	0.10	0.200	1.200
SMD0805R050SF	5	6.0	30	0.50	1.00	0.5	8.0	0.10	0.100	0.850
SMD0805R050SF12v	5	12.0	30	0.50	1.00	0.5	8.0	0.10	0.100	0.850
SMD0805R050SF16v	5	16.0	30	0.50	1.00	0.5	8.0	0.10	0.100	0.850
SMD0805R050SF24v	5	24.0	30	0.50	1.00	0.5	8.0	0.10	0.100	0.850
SMD0805R075SF	7	6.0	35	0.75	1.50	0.6	8.0	0.20	0.070	0.385
SMD0805R075SF12v	7	12.0	35	0.75	1.50	0.6	8.0	0.20	0.070	0.385
SMD0805R100SF	0	6.0	35	1.00	1.95	0.6	8.0	0.30	0.040	0.230
SMD0805R100SF12v	0	12.0	35	1.00	1.95	0.6	8.0	0.30	0.040	0.230
SMD0805R110SF	0	6.0	35	1.10	2.20	0.6	8.0	0.30	0.035	0.210
SMD0805R110SF12v	0	12.0	35	1.10	2.20	0.6	8.0	0.30	0.035	0.210
SMD0805R125SF	12	6.0	35	1.25	2.50	1.5	8.0	0.60	0.025	0.140
SMD0805R150SF	15	6.0	30	1.50	3.00	1.0	8.0	0.50	0.015	0.130

V max = Maximum operating voltage device can withstand without damage at rated current (I max).

I max = Maximum fault current device can withstand without damage at rated voltage (V max).

I hold = Hold Current. Maximum current device will not trip in 25°C still air.

I trip = Trip Current. Minimum current at which the device will always trip in 25°C still air.

P_d = Power dissipation when device is in the tripped state in 25°C still air environment at rated voltage.

R i min/max = Minimum/Maximum device resistance prior to tripping at 25°C.

R1max = Maximum device resistance is measured one hour post reflow.

CAUTION : Operation beyond the specified ratings may result in damage and possible arcing and flame.

Type FSMD0805

SMD Polyswitch Resettable Devices



Environmental Specifications

Test	Conditions	Resistance change
Passive aging	+85°C, 1000 hrs.	±5% typical
Humidity aging	+85°C, 85% R.H. , 168 hours	±5% typical
Thermal shock	+85°C to -40°C, 20 times	±33% typical
Resistance to solvent	MIL-STD-202,Method 215	No change
Vibration	MIL-STD-202,Method 201	No change
Ambient operating conditions : - 40 °C to +85 °C		
Maximum surface temperature of the device in the tripped state is 125 °C		

Thermal Derating Chart

Recommended Hold Current(A) at Ambient Temperature(°C)

Model	Ambient Operation Temperature								
	-40°C	-20°C	0°C	25°C	40°C	50°C	60°C	70°C	85°C
SMD0805R005SF	0.070	0.060	0.055	0.050	0.040	0.035	0.030	0.025	0.015
SMD0805R010SF	0.14	0.12	0.11	0.10	0.08	0.07	0.06	0.05	0.03
SMD0805R020SF	0.28	0.25	0.23	0.20	0.17	0.14	0.12	0.10	0.07
SMD0805R035SF	0.47	0.44	0.39	0.35	0.30	0.27	0.24	0.20	0.14
SMD0805R050SF	0.68	0.62	0.55	0.50	0.40	0.37	0.33	0.29	0.23
SMD0805R075SF	1.00	0.90	0.79	0.75	0.63	0.57	0.53	0.41	0.34
SMD0805R100SF	1.35	1.25	1.15	1.00	0.82	0.74	0.65	0.55	0.42
SMD0805R110SF	1.45	1.35	1.20	1.10	0.92	0.84	0.75	0.65	0.52
SMD0805R125SF	1.65	1.53	1.36	1.25	1.05	0.95	0.85	0.74	0.59
SMD0805R150SF	1.98	1.84	1.63	1.50	1.26	1.14	1.02	0.88	0.71

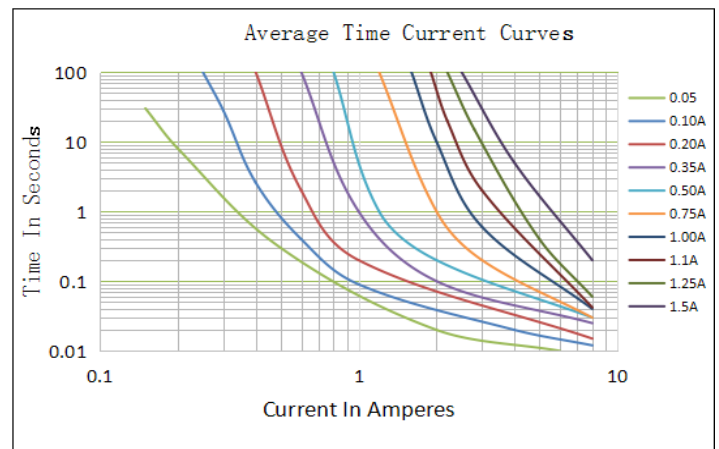
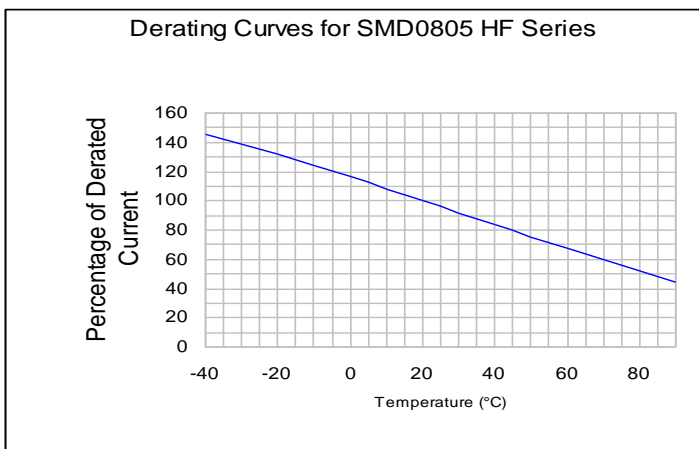

Soldering Parameters

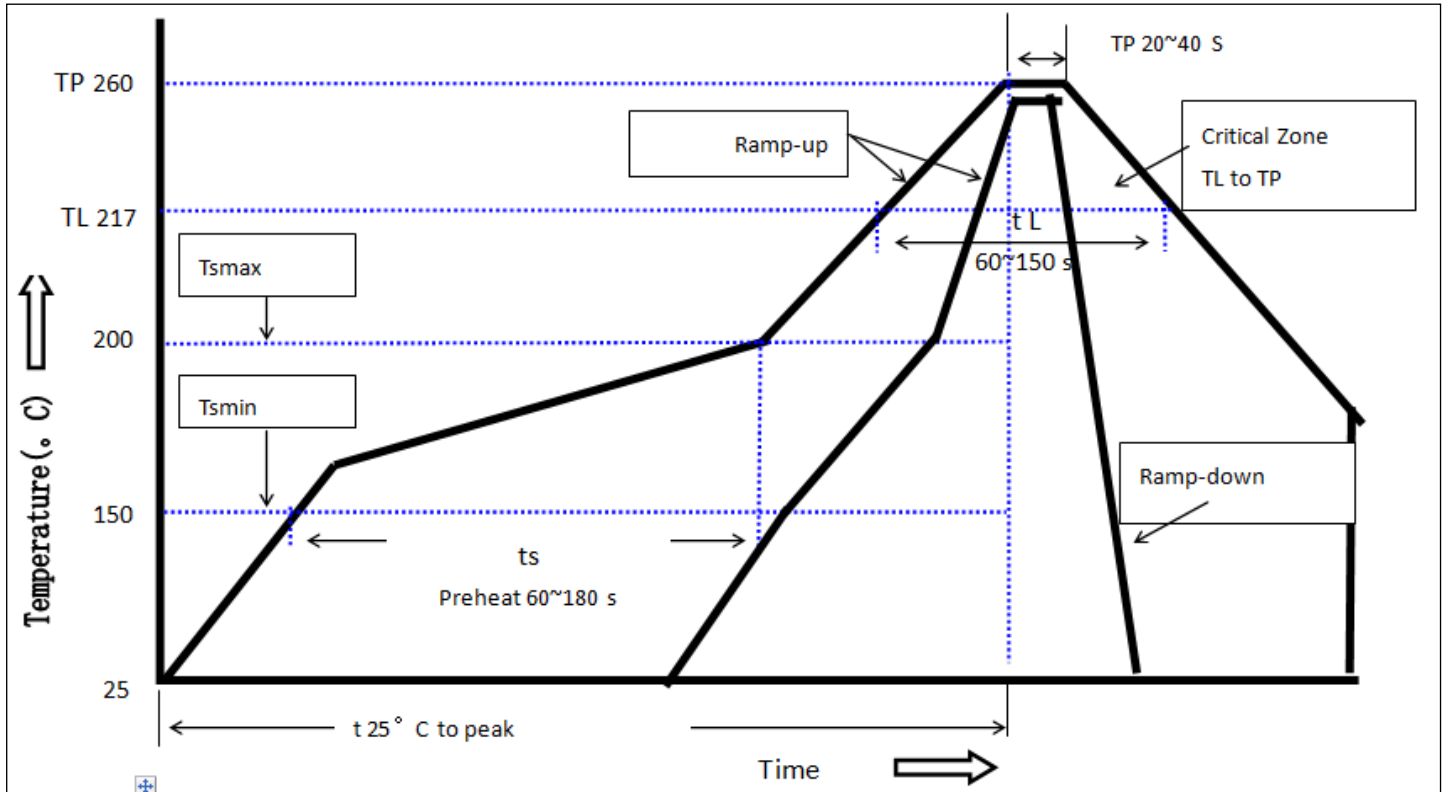

Profile Feature	Pb-Free Assembly
Average Ramp-Up Rate(Ts max to T p)	3°C/second max.
Preheat -Temperature Min(Ts min) -Temperature Max(Ts max) -Time(Ts min to Ts max)	150°C 200°C 60~180 seconds
Time maintained above: -Temperature(TL) -Time(tL)	217°C 60~150 seconds
Peak Temperature(Tp)	260°C
Ramp-Down Rate	6°C/second max.
Time 25°C to Peak Temperature	8 minutes max.
Storage Condition	0°C~35°C,30%-60%RH

Recommended reflow methods: IR, vapor phase oven, hot air oven, N2 environment for lead-free

Recommended maximum paste thickness is 0.25mm

Devices can be cleaned using standard industry methods and solvents.

Note 1:All temperature refer to topside of the package, measured on the package body surface.

Note 2: If reflow temperatures exceed the recommended profile, devices may not meet the performance requirements.

Type FSMD0805

SMD Polyswith Resettable Devices



Physical Dimensions(mm)

Model	A		B		C		D	E
	Min.	Max.	Min.	Max.	Min.	Max.	Min.	Max.
SMD0805R005SF	2.00	2.20	1.20	1.50	0.40	0.90	0.20	0.10
SMD0805R005SF30V	2.00	2.20	1.20	1.50	0.40	0.90	0.20	0.10
SMD0805R010SF	2.00	2.20	1.20	1.50	0.40	0.90	0.20	0.10
SMD0805R010SF30V	2.00	2.20	1.20	1.50	0.40	0.90	0.20	0.10
SMD0805R020SF	2.00	2.20	1.20	1.50	0.35	0.80	0.20	0.10
SMD0805R020SF12V	2.00	2.20	1.20	1.50	0.35	0.80	0.20	0.10
SMD0805R020SF16V	2.00	2.20	1.20	1.50	0.35	0.80	0.20	0.10
SMD0805R020SF24V	2.00	2.20	1.20	1.50	0.35	0.80	0.20	0.10
SMD0805R035SF	2.00	2.20	1.20	1.50	0.35	0.80	0.20	0.10
SMD0805R035SF	2.00	2.20	1.20	1.50	0.35	0.80	0.20	0.10
SMD0805R035SF12v	2.00	2.20	1.20	1.50	0.35	0.80	0.20	0.10
SMD0805R035SF13.2v	2.00	2.20	1.20	1.50	0.35	0.80	0.20	0.10
SMD0805R035SF16v	2.00	2.20	1.20	1.50	0.35	0.80	0.20	0.10
SMD0805R050SF	2.00	2.20	1.20	1.50	0.35	0.80	0.20	0.10
SMD0805R050SF12v	2.00	2.20	1.20	1.50	0.35	0.80	0.20	0.10
SMD0805R050SF16v	2.00	2.20	1.20	1.50	0.50	1.10	0.20	0.10
SMD0805R050SF24v	2.00	2.20	1.20	1.50	0.50	1.10	0.20	0.10
SMD0805R075SF	2.00	2.20	1.20	1.50	0.50	1.00	0.20	0.10
SMD0805R075SF12v	2.00	2.20	1.20	1.50	0.50	1.00	0.20	0.10
SMD0805R100SF	2.00	2.20	1.20	1.50	0.70	1.20	0.20	0.10
SMD0805R100SF12v	2.00	2.20	1.20	1.50	0.70	1.20	0.20	0.10
SMD0805R110SF	2.00	2.20	1.20	1.50	0.70	1.20	0.20	0.10
SMD0805R110SF12v	2.00	2.20	1.20	1.50	0.70	1.20	0.20	0.10
SMD0805R125SF	2.00	2.20	1.20	1.50	0.70	1.50	0.20	0.10
SMD0805R150SF	2.00	2.20	1.20	1.50	0.70	1.50	0.20	0.10

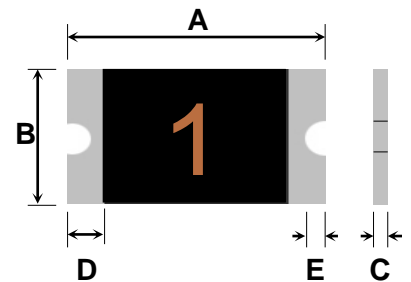

Termination Pad Characteristics

Terminal pad materials: Tin-plated Nickel-Copper

Terminal pad solder ability: Meets EIA specification RS186-9E and ANSI/J-STD-002 Category 3.

Recommended Pad Layout (mm)

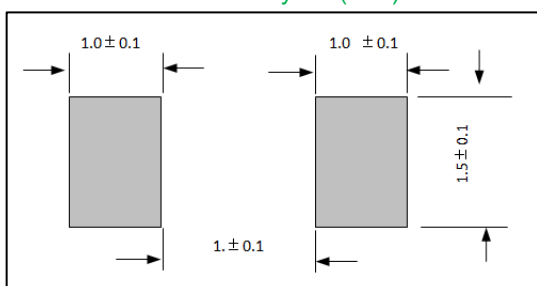

Packaging Quantity

Part Number	Quantity
SMD0805R005.010.020.035.050.SF	5,000 pcs/reel
SMD0805R075.100.110SF	4,000 pcs/reel
SMD0805R125.150SF	3,500 pcs/reel

Tape & reel packaging per EIA481-1

Type FSMD0805

SMD Polyswith Resettable Devices



Tape And Reel Specifications (mm)

Governing Specifications	EIA 481-1
W	8.0 ± 0.3
P0	4.0 ± 0.10
P1	4.0 ± 0.10
P2	2.0 ± 0.05
A0	1.45 ± 0.10
B0	2.30 ± 0.10
B1max.	4.35
D0	1.55 + 0.1, -0
F	3.5 ± 0.05
E1	1.75 ± 0.10
E2min.	6.25
T	0.25
T1max.	0.1
K0	0.74 ± 0.1
Leader min.	390
Trailer min.	160
Reel Dimensions	
A max.	178
N min.	60
W1	9.0 ± 0.5
W2	12.0 ± 0.05
Storage And Handling	
Storage conditions: 30°C max, 30%-60% R.H.	
Devices may not meet specified performance	
if storage conditions are exceeded.	

EIA Tape Component Dimensions

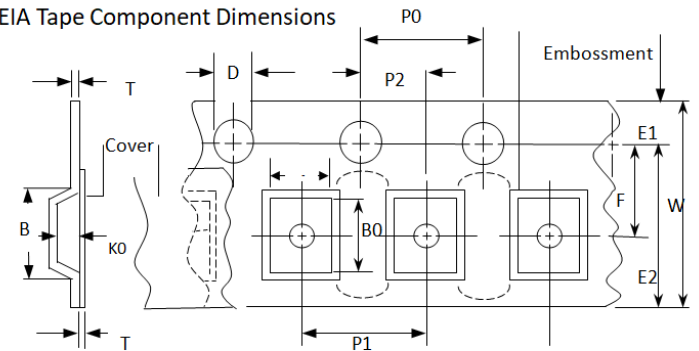

EIA Reel Dimensions

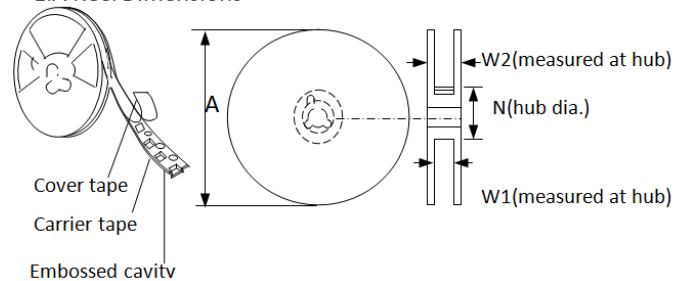

Part Number System

SMD	0805	R	□□□	S	F	□□V
Surface Mount Device	Device Dimensions: Length/width(Unit:1/100 inch) Size 2012 mm / 0805 inch	Factory code	Holding Current Rating	Tin-plated Nickel-Copper	Lead-Free	Special voltage Rating(Optional)

▼PPTC使用注意事项:

- PPTC为热敏元件，对环境温度比较敏感，建议在PPTC周围不要设计热源元件，尽量减少外部热源的影响。
- 请在规格书规定的参数下使用，超出电压电流规格值，会导致PPTC出现电弧，阻值升高，甚至烧片。
- 规格书的电气特性，均是基于在本公司指定测试板经过一次回流焊之后的测试；如果客户有二次回流焊或者注塑点胶等其他热工序，会对上述参数有一定程度的衰减，需要验证其适用性。
- PPTC贴片产品是为SMT工艺设计的封装形式，焊接工艺为回流焊；要求客户遵守我们推荐的焊盘布局和回流焊配置文件。不正确的电路板布局或回流配置可能会对PPTC的可焊性性能产生负面影响。焊接工艺可参考本司推荐的回流焊曲线。如果回流焊温度超过推荐的值，PPTC将有可能受到损伤。使用手工焊及波峰焊接PPTC可能会导致产品焊后电阻超出规格。
- 某些注塑料、单组份、双组份固化胶粘剂、硅胶、侵蚀性溶剂污染PPTC材料破坏芯片，需要对注塑料胶料等材料牌号以及应用参数（如温度、时间等）进行验证，以确保产品及工艺的匹配性，确认不会影响PPTC性能之后方可使用。PPTC在充电线端应用中，建议使用PP类材料做内膜，禁止使用TPE类与PVC类等材料做内膜。
- PPTC贴装或使用过程中，不建议使用洗板水或其他清洗剂进行清洗。如必须使用，需要验证各类清洗剂、洗板水以及溶剂的适用性，确认不会影响PPTC性能之后方可使用。已知对PPTC有影响的化学药品包括但不限于醚类、苯类、酮类以及脂类等较强溶解性、破坏性的有机化合物，清洗后将产品放置于敞开的环境中至少24小时，将残留的溶剂进行充分的挥发。
- 装配过程中，避免用暴力砸、挤、压、拉、扭、刺等方式作用PPTC本体，以免引起PPTC性能衰减。
- PPTC元件是为电路中偶尔出现的过流而设计的，不建议用在连续且持续过流的电路中。
- 本公司SMD PPTC湿敏等级为2级，为密封包装。客户如在库存中发现有包装破损的，立即将产品隔离处理；使用时如有余料，需恢复之前包装状态，做密封保存，否则会影响产品性能导致焊后电阻越规格。
- 产品废弃时，可按照一般电子废弃物处理，具体材料组成可参见MSDS。